

**SIDE VIEW**

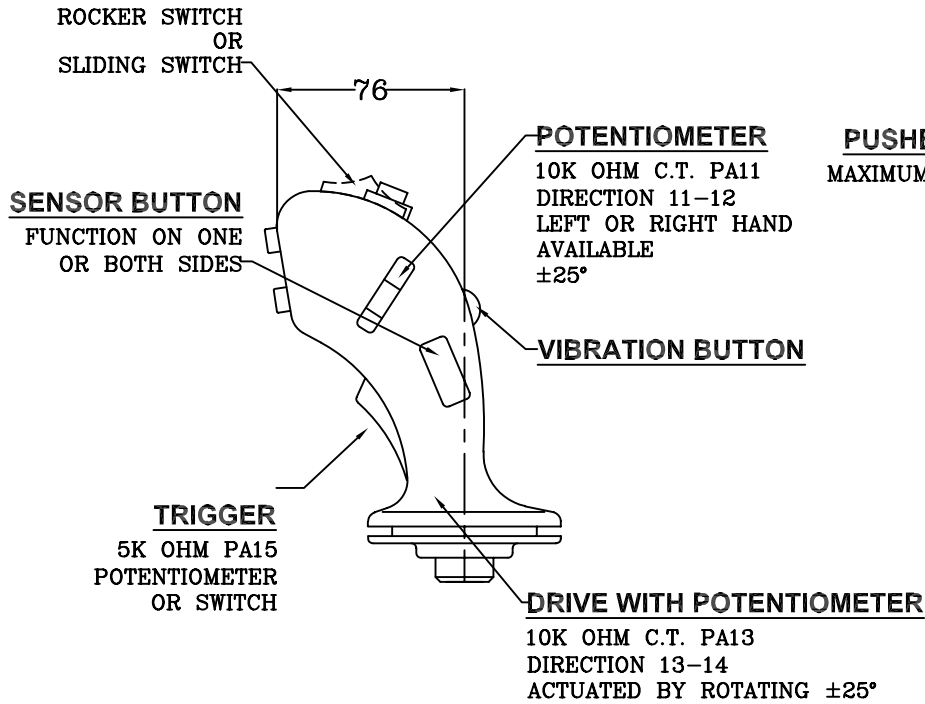

**FRONT VIEW**

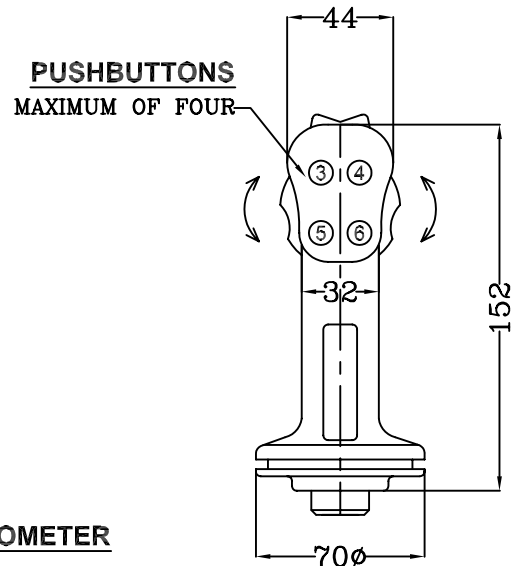

**TOP VIEW**

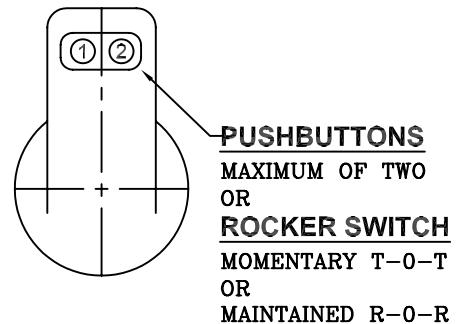

**TOP VIEW**

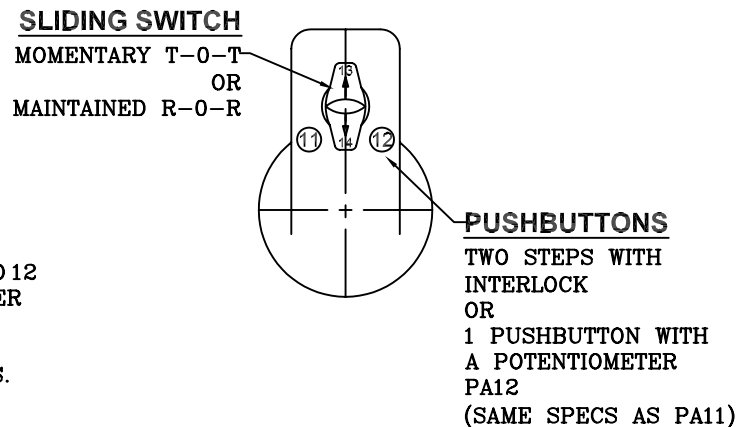

**CONTACT RATINGS AND SPECIFICATIONS**

CONTACT RATINGS: 0.5A 110V AC15 RES. 1.5A 24V DC13

**PUSHBUTTONS:** SPST N.O.

**ROCKER SWITCH:** SPST N.O. MAINTAINED OR MOMENTARY

DEGREE OF PROTECTION FRONT IP65

**IMPORTANT: PLEASE NOTE**

ROCKER SWITCH CAN ONLY BE COMBINED WITH FRONT MOUNTED PUSHBUTTONS 5 AND 6

SIDE MOUNTED POTENTIOMETER CAN ONLY BE COMBINED WITH FRONT MOUNTED PUSHBUTTONS 5 AND 6

SIDE MOUNTED POTENTIOMETER CANNOT BE COMBINED WITH TRIGGER SWITCH POTENTIOMETER

SLIDING SWITCH CANNOT BE COMBINED WITH PUSHBUTTONS 1,2,4 AND 6

POTENTIOMETER PA12 INSTALLED IN POS. 11 AND 12 CANNOT BE COMBINED WITH SIDE POTENTIOMETER PA11

PUSHBUTTONS WITH 2 STEPS INSTALLED IN POS. 11 AND 12 CANNOT BE COMBINED WITH POTENTIOMETERS PA11 AND PA12.

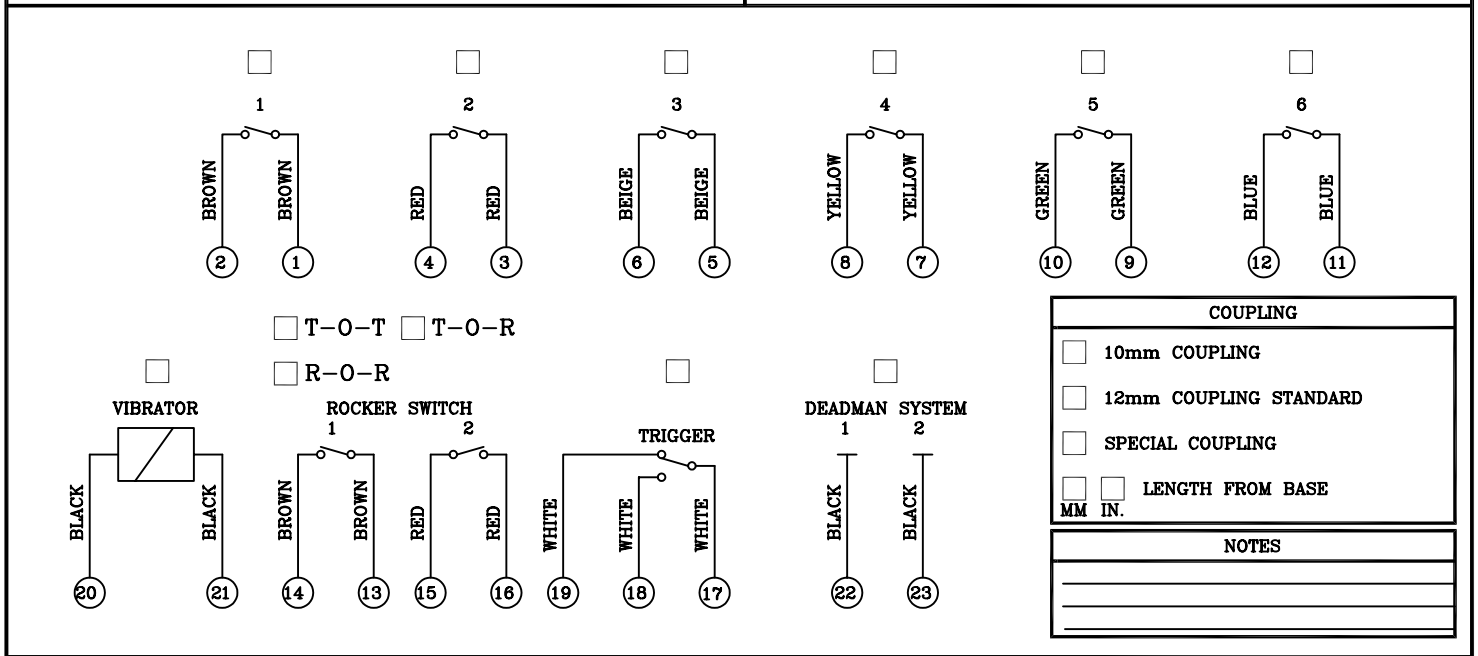
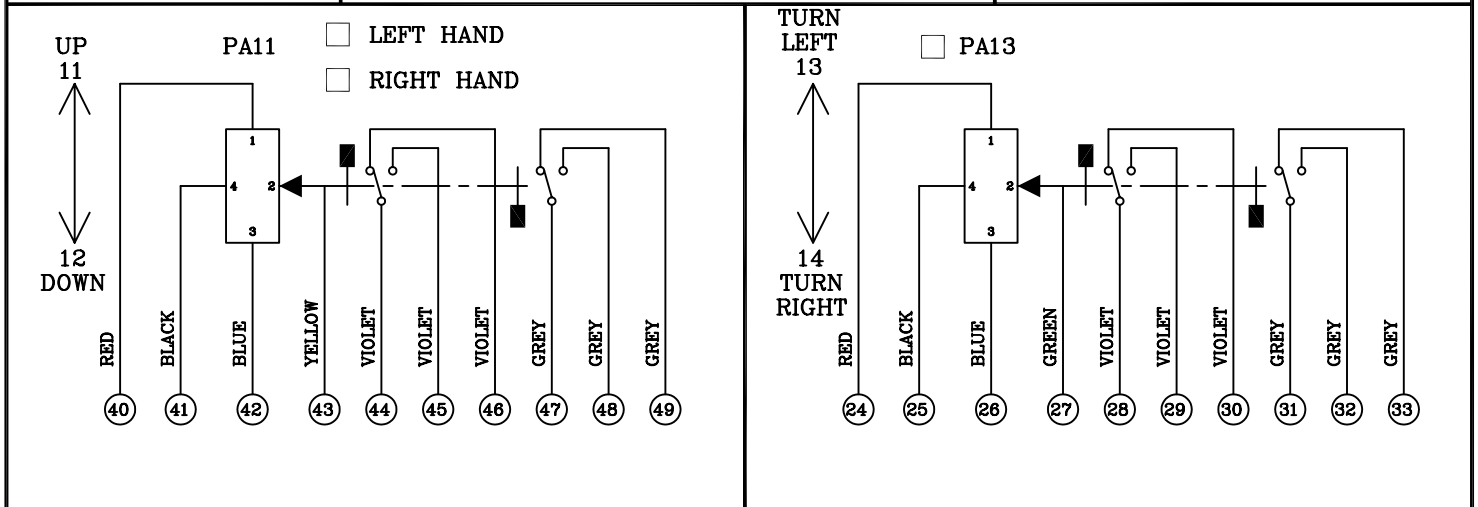
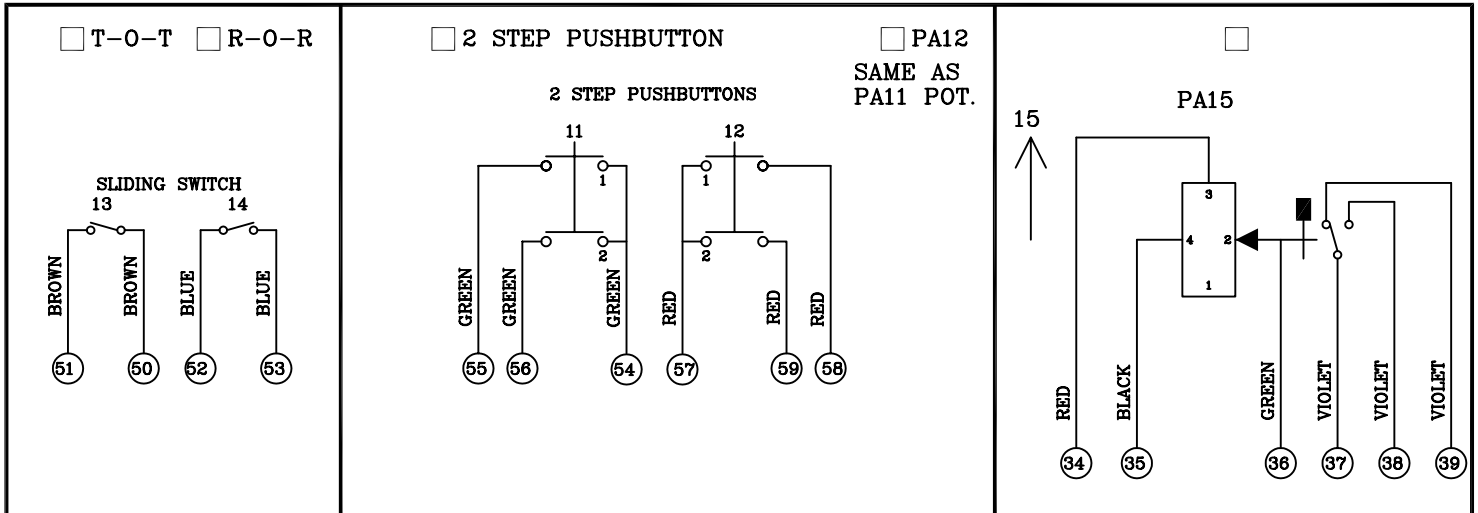

DATE	NAME	JOB#	FROM	PART#
------	------	------	------	-------